

ASSEMBLY INSTRUCTIONS

P23-MTBB T-Max Marching Bass Drum Carrier
Updated 2022

PARTS LIST

	PART DESCRIPTION	SKU	QTY
1	T-Max Arm Hook (Right)	P600-0050	1
2	T-Max Arm Hook (Left)	P600-0051	1
3	Arm Hook Foam Pad Set (R & L)	P600-0066	1
4	T-Max Top	P600-0044	1
5	T-Max Bottom	P600-0045	1
6	Bass Support Bar (A & B)	P23-MTBR	1
7	T-Max Belly Plate	P600-0048	1
8	T-Max Tongue (3/8")	P600-0047	1
9	Mini Dynasty Logo (white)	P900-0030	
10	Belly Plate Foam Pad	P600-0017	2
11	Bass Tongue Foam Pad	P600-0009	2
12	J-Hook Assembly Pack:	P600-0022K	2
	5/16" J-Hooks		2
	5/16" Serrated Flange Lock Nuts		4
13	Frame Hardware Pack:	P900-TMF5	
	1/4" Serrated Flange Lock Nuts		12
	1/4" x 3/4" Carriage Bolts		8
	1/4" x 1" Carriage Bolts		4



4X

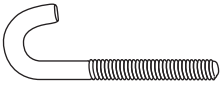

2X



12X



8X

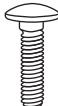

4X

Please follow assembly instructions carefully to ensure optimal product performance.

Questions? Contact us at info@marchingusa.com or (469) 422-2681.

1

Install the J-Hooks from the J-Hook Assembly Pack (part 12) onto the Arm Hooks (parts 1 & 2) using two 5/16" lock nuts per J-Hooks as shown.



2

Find the Arm Hook Foam Pads (part 3) and peel off the Velcro backing. Trim the loose strip of Velcro to install to its corresponding Arm Hook, leaving a gap around the bolt as shown.



3

Find the Belly Plate Foam Pad (part 10) and peel off the Velcro backing. Install the strip of loose Velcro to the Belly Plate (part 7).



4

Attach the Bar Bottom (part 5) to the Tongue (part 8) using two 1/4" x 1" Carriage Bolts from the Frame Hardware Pack (part 13).

Bar Bottom & Tongue Before Assembly ▼

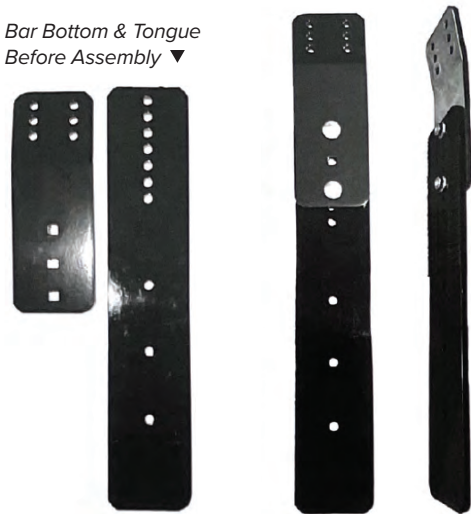

5

Attach the Bar Top (part 4) to the Bar Bottom (part 5) using two 1/4" x 3/4" Carriage Bolts and two lock nuts from the Frame Hardware Pack (part 13).



◀ NOTE: Keep the Bar Top above the Bar Bottom when installing.

6

Assemble the Bass Support Bar (part 6A & 6B) using two 1/4" x 3/4" Carriage Bolts and two 1/4" lock nuts.



◀ NOTE: Keep part 6B above part 6A when attaching them.

7

Stack the Belly Plate (part 7), Tongue (part 8), and Bass Support Bar (part 6A & 6B) and attach using two 1/4" Carriage Bolts and two 1/4" lock nuts.

Attach the Bass Tongue Velcro to the back of the Bass Tongue and cut where the Bass Tongue meets the Bar Bottom.

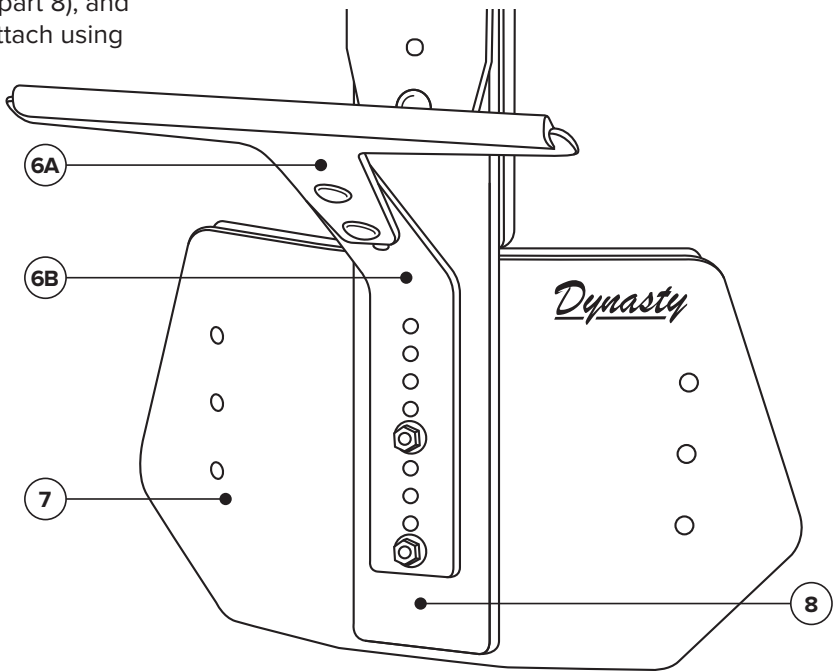

8

Attach Arm Hooks (parts 1 & 2) to Bar Top using four 1/4" x 3/4" Carriage Bolts and four lock nuts.

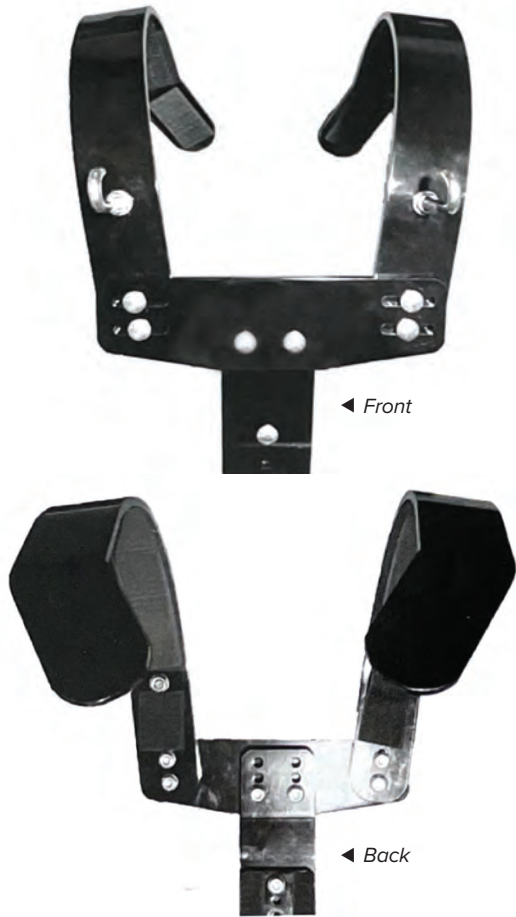

9

Install remaining foam pads.



Questions? We can help!

Contact us at (469) 422-2681
or email info@marchingusa.com.